

EFFECTIVE PASSIVE TREATMENT OF MINE EFFLUENT USING A PHOSPHATE REACTIVE MEDIUM¹

Cheryl S. Ross, Rens B. Verburg, Bryony Stasney, and Lynn McCloskey²

Abstract. The Nevada Stewart Mine is an abandoned lead-zinc mine located within the Coeur d'Alene Mining District, Idaho. In 2002, a passive Apatite IITM Treatment System (ATS) was installed by MSE Technology Applications, Inc. (MSE) to treat metal-laden adit discharge (pH values are circum-neutral). The treatment medium consisted of a mixture of fish bone (Apatite IITM) and gravel.

Monthly performance monitoring of the ATS over a 21-month period showed attenuation of cadmium, lead, zinc, iron and manganese. In comparison to the ATS inflow, redox conditions in the outflow were more reduced, with higher calcium, sulfide, nitrogen and phosphorus concentrations. Geochemical modeling using the United States Geological Survey code PHREEQC was conducted to identify the reaction mechanisms responsible for the observed changes in water quality. Modeling results were reviewed in the context of available solid-phase data (i.e., chemical composition and detailed mineralogy) and experience at other sites to identify the most likely attenuation mechanisms. Zinc attenuation was attributed to precipitation as zinc sulfide, subsequently confirmed by mineralogical analysis. Collagen was identified as the most likely source of nitrogen release from the ATS, and was likely responsible for reducing conditions in the effluent. The increase in phosphorus concentrations was attributed to dissolution of the Apatite IITM and subsequent formation of insoluble metal phosphates. Manganese phosphate [MnHPO₄] and chloropyromorphite [Pb₁₀(PO₄)₆Cl₂] were identified as possible controls on manganese and lead concentrations, respectively.

Additional Key Words: Apatite IITM, manganese, lead, zinc, PHREEQC, geochemical modeling

¹ Paper presented at the 7th International Conference on Acid Rock Drainage (ICARD), March 26-30, 2006, St. Louis MO. R.I. Barnhisel (ed.) Published by the American Society of Mining and Reclamation (ASMR), 3134 Montavesta Road, Lexington, KY 40502

² Cheryl S. Ross is a senior hydrogeochemist, Golder Associates Inc., Redmond, WA 98052. Rens B. Verburg is a principal geochemist, Golder Associates Inc., Redmond, WA 98052. Bryony Stasney is a senior hydrogeologist, Golder Associates Inc., Coeur d'Alene, ID 83814. Lynn McCloskey is a senior hydrogeologist/mining engineer, Quality Maintenance Contractors, Inc., Butte, MT 59701.

7th International Conference on Acid Rock Drainage, 2006 pp 1728-1752

DOI: 10.21000/JASMR06021728

<https://doi.org/10.21000/JASMR06021728>

Introduction

Project Background

The Nevada Stewart Mine is an abandoned Pb-Zn mine located within the Coeur d'Alene Mining District, Idaho. Adit discharge from abandoned mine workings is estimated at 190 liters per minute (L/min). The primary contaminants in adit discharge are Pb, Mn and Zn.

In 2002, a passive Apatite II™ Treatment System (ATS) was installed to treat metal-laden adit discharge. Prior to installation of the subsurface ATS, adit discharge flowed into Highland Creek. The system was designed to treat approximately 40% (~76 L/min) of the adit discharge, which is captured upon exiting the adit and directed to the treatment system by gravity. The ATS includes the following components (Fig. 1 and 2):

- A 3,785-liter retention-settling basin (Tank 1);
- Three parallel 11,355-liter treatment tanks (Tanks 2, 3 and 4) filled with a mixture of fish bone (Apatite II™) and gravel (approximately 75% to 25% by volume apatite/gravel mix). The total masses of gravel and Apatite II™ used in the entire treatment system (i.e., split equally among all three tanks) were approximately 10,000 kg and 5,000 kg, respectively; and,
- An infiltration catch basin.

The objective of this study was to obtain a greater understanding of the mechanisms responsible for metals attenuation at the Nevada Stewart Site. Performance monitoring of the ATS system included collection and analysis of both water and solid phase samples. These data were evaluated and geochemical modeling was conducted to identify possible reaction mechanisms responsible for the observed changes in water quality.

Apatite Treatment Theory

Extensive research has been conducted to identify the mechanisms responsible for metals attenuation by apatite (e.g., Ma et al., 1993; Ma et al., 1994; Xu and Schwartz, 1994; Chen et al., 1997a). Possible attenuation mechanisms include mineral precipitation, adsorption and cation substitution.

The Nevada Stewart Mine ATS uses Apatite II™ as the reactive medium. Apatite II™ is composed of fish bone, and therefore hydroxyapatite (HA) (nominal formula is $\text{Ca}_5(\text{PO}_4)_3(\text{OH})$), a component of the bones and teeth of vertebrates, is the primary mineral phase. The specific chemical composition of Apatite II™ is $\text{Ca}_{10-x}\text{Na}_x(\text{PO}_4)_{6-x}(\text{CO}_3)_x(\text{OH})_2$ (where x is less than 1) (Wright et al., 2004). In comparison to end-member HA, Apatite II™ has partial substitution of CO_3^{2-} ions for PO_4^{3-} and Na for Ca.

Bone is also composed of 30 to 35% organic material (on a dry weight basis), of which the primary constituent (95%) is collagen (Turek and Lippincott, 1985). The nominal chemical composition of collagen can be represented by $\text{C}_{102}\text{H}_{149}\text{O}_{38}\text{N}_{31}$.

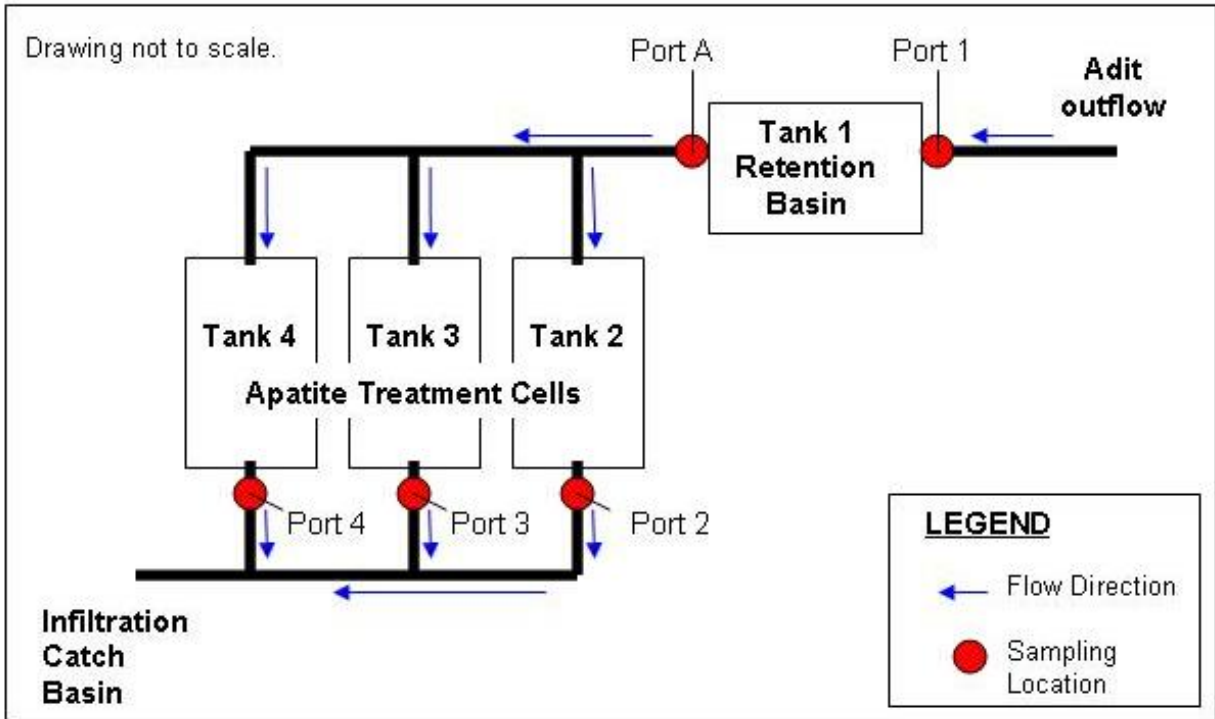

Figure 1. Schematic of Treatment System.

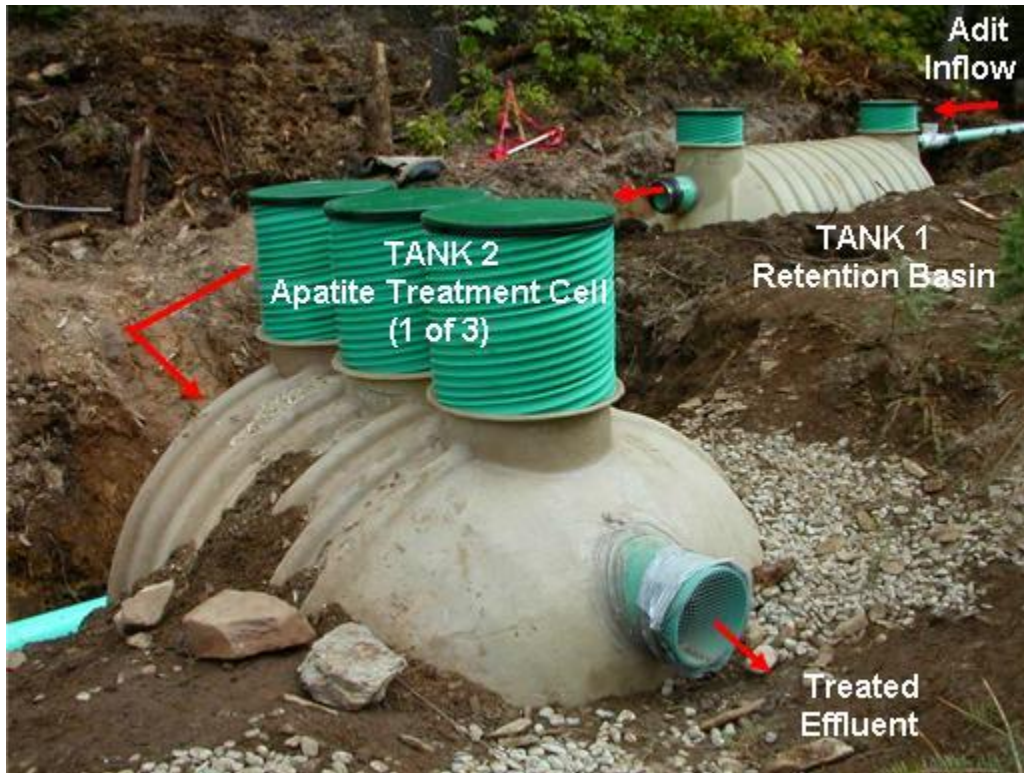
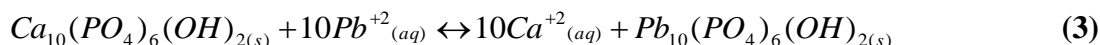
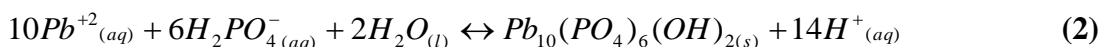
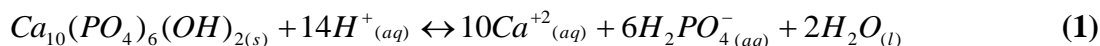

Figure 2. Photograph of the Treatment System During Construction (white treatment tanks with green manholes for access).

Research on metals attenuation by apatite has included testing of a variety of apatite minerals including synthetic HA (Ma et al., 1993; Xu and Schwartz, 1994), natural apatite (Ma et al., 1993; Chen et al., 1997a, Chen et al., 1997b) and Apatite II™ (Bostick et al., 2000). Mechanisms proposed for Pb, Cd, and Zn attenuation by apatite are discussed below. Manganese attenuation by apatite is not specifically addressed, as this constituent appears to have received less research focus than Pb, Cd and Zn.

Lead. Ma et al. (1993) proposed the following reaction sequence (Equations 1 and 2) to describe Pb attenuation by HA (Equation 3 shows the resultant reaction):



The dissolution of HA results in a release of phosphorus into solution that reacts with aqueous Pb to form the Pb phosphate hydroxypyromorphite (HP). The relative solubilities of HA and HP make the above reaction sequence possible, HA being the more soluble mineral phase (assuming dissolution in pure water). Modeled HA and HP solubilities in pure water as a function of pH are shown in Fig. 3. As pH increases, the solubilities of HA and HP decrease. Solution pH is therefore a key factor in the effectiveness of Pb attenuation by HA. Ma et al. (1993) noted that for optimal Pb removal, solution pH must be low enough to dissolve HA, yet high enough to maintain a low solubility of HP, thereby keeping aqueous Pb concentrations low. It is notable that in a mine drainage solution, the presence of Ca and possibly PO_4^{3-} would influence the relative solubilities of HA and HP.

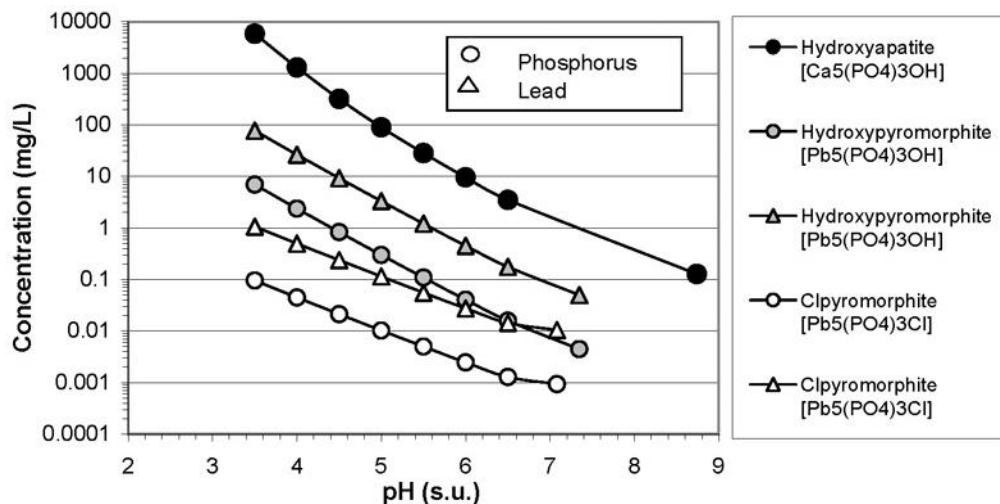

Figure 3: Phosphate Mineral Solubility

Subsequent work by Ma et al. (1994) investigated the effects of anions in solution, specifically NO_3^- , Cl^- , F^- , SO_4^{2-} and CO_3^{2-} on HA-Pb interactions. In the presence of NO_3^- , PO_4^{3-}

and CO_3^{2-} , HP was observed to form; however, in Cl⁻ and F-dominated systems, chloropyromorphite (CP) $[\text{Pb}_{10}(\text{PO}_4)_6\text{Cl}_2]$ and fluoropyromorphite $[\text{Pb}_{10}(\text{PO}_4)_6\text{F}_2]$ precipitated, respectively. The solubility of CP relative to HA and HP is shown in Fig. 3.

Research by Xu and Schwartz (1994) supports the work of Ma et al. These authors also noted the formation of HP $[\text{Pb}_5(\text{PO}_4)_3\text{OH}]$ in Cl⁻-free systems and CP when chloride was present. HP precipitation was observed to be isolated from the HA grains; whereas, CP precipitated onto the HA grains. The coating of HA grains by CP is relevant with respect to the long-term dissolution and effectiveness of Pb attenuation by HA. These reactions were kinetically fast (on the order of minutes), with the dissolution of HA being the rate-limiting step.

Cadmium and Zinc. Chen et al. (1997b) studied reaction of Cd and Zn solutions with apatite from a sedimentary phosphate rock deposit. Precipitation of otavite $[\text{CdCO}_3]$ was observed, the carbonate being supplied by the carbonate-bearing apatite (gas-free deionized distilled water was used in the study and the reaction was conducted in air-tight centrifuge tubes). No other Cd or Zn mineral phases were identified; however, the possibility of other amorphous or crystalline phases (for example Cd and Zn phosphates) was not entirely dismissed. In addition to precipitation of otavite, Cd and Zn attenuation was attributed to surface adsorption.

Ma et al. (1994) studied the effects of competing metal ions, including Cd and Zn, on Pb-HA reactions. Adsorption onto HA and precipitation of amorphous to poorly crystalline phases were proposed for the observed attenuation of Cd and Zn.

ATS System Monitoring

Water Quality Monitoring

Monthly performance monitoring of the ATS system was conducted between November 2002 and August 2004. Treatment system influent (Port 1 and Port A) and effluent (Ports 2, 3 and 4) samples were collected (sampling locations shown in Fig. 1). The two influent stations, Port 1 and Port A, are located at the inflow and the outflow of the retention basin, respectively.

Two levels of monitoring were conducted, described as baseline and target suites (Table 1). Baseline monitoring was conducted at Ports 1 through 4 on three occasions. The target analyte suite was determined during the other 17 sampling events.

Bacteriological Characterization

A single round of SO_4^{2-} reducing bacteria (SRB) enumerations was conducted on influent and effluent samples collected in September 2004. SRB are a group of anaerobic bacteria which reduce sulfate to sulfide.

Solid Phase Characterization

Chemical analysis of the reactive medium was performed by Dr. Steve Anderson of Montana Tech of the University of Montana (Montana Tech) (Anderson and Clary, 2004; Clary, 2004). The fish bone/gravel mixture was analyzed prior to placement in the tanks, and samples of treatment tank solids were collected during tank operation in July 2003. The treatment tank solids were collected at surface and from four discrete depths within each of the three treatment tanks (i.e., 8, 16, 24 and 32 inches below the surface). Samples were submitted to SVL Analytical, Inc. (SVL) in Kellogg, Idaho and analyzed by Environmental Protection Agency (EPA) Test Method 3050B for the following constituents: Ca, Cd, Fe, Mn, Pb and Zn. The sample fractions were biased toward the fish bone fraction of the samples (as opposed to the

gravel fraction), and the analytical results are therefore representative of the composition of the fish bone. Mineralogical analysis (i.e., x-ray diffraction (XRD) and scanning electron microscopy/energy dispersive x-ray spectroscopy (SEM/EDX)) were also conducted on the solid samples.

Table 1. Performance Water Quality Monitoring Analytical Suite

Constituent	ATS Influent and Effluent (Ports 1 to 4)		Retention Basin Effluent (Port A)
	Baseline	Target	Target
<i>Field Parameters</i>			
Conductivity, Dissolved Oxygen, Eh, pH, Temperature	x	x	x
<i>General Parameters – Major Ions</i>			
Calcium	x	x	x
Alkalinity, Acidity, Magnesium, Sulfate, Sulfide	x	x	
Chloride, Fluoride, Potassium, Sodium	x		
<i>Dissolved and Total Metals and Metalloids</i>			
Iron, Manganese, Zinc	x	x	x
Cadmium, Lead	x	x	
Aluminum, Antimony, Arsenic, Beryllium, Chromium, Copper, Mercury, Nickel, Selenium, Silver, Silicon, Thallium	x		
<i>Nutrients</i>			
Dissolved Orthophosphate, Dissolved Total Phosphorus, Total Phosphorus, Kjeldahl Nitrogen, Nitrate, Nitrite, Total Ammonia	x	x	
<i>Bacteriological</i>			
Coliform Bacteria ^a	x		

^aColiform bacteria monitored at Ports 1 and 4.

In September 2004, a second round of solid-phase sampling was conducted by MSE. Samples were once again submitted to SVL. Sample collection and analysis protocols (i.e., total metals analysis) were the same as those employed by Montana Tech in July 2003. The metal results from the two sampling events are therefore directly comparable.

ATS Monitoring Results

Flow Conditions

Treatment system inflow and outflows were measured using Thel Mar weirs. Measured inflow (Port 1) to the ATS ranged from approximately 19 to 114 L/min, with peak flows being recorded in the late spring 2003 (May 2003). In February 2003, cleaning of the influent and effluent lines was required to maintain flow. To enhance tank permeability, air sparging was performed on four occasions: May 29, 2003, October 21, 2003, February 10, 2004 and April 4, 2004. Air sparging was conducted after routine monitoring. An air compressor was used to supply air for injection into the treatment tanks via a pipe with holes at its base inserted into the tanks through the manhole access ports (access ports shown in Fig. 2). The air flow rate and time of injection were not recorded.

The inflow was unintentionally distributed unequally among the three parallel treatment tanks. Flow variability among the tanks was attributed to differences in the permeability of the treatment cells due to variability in the degree of settling and secondary mineral precipitation reactions. Since March 2003, Port 4 generally recorded the least outflow, ranging from less than 5% to approximately 30% of the total outflow. Between March 2003 and April 2004, with the exception of three months, Port 3 recorded the highest outflow, accounting for up to 79% of the total flow. Between June and August 2003, peak outflows were measured at Port 2. During the last four months of monitoring (May to August 2004), Port 2 also recorded the highest outflows, generally accounting for greater than 50% of the total outflow.

Influent and Effluent Chemistry

The ranges of influent and effluent concentrations for the primary contaminants in adit discharge are summarized in Table 2.

Observed absolute reductions in Zn concentrations were higher than for Pb and Mn. Lead entered the ATS at the part per billion (ppb) level; whereas, Zn concentrations in the influent were higher, at part per million (ppm) levels. Manganese influent concentrations were intermediate to Pb and Zn.

Table 2. ATS Influent and Effluent Pb, Mn and Zn Concentrations

Constituent (Dissolved Phase)	Influent	Effluent
	(Port 1)	(Ports 2, 3 and 4)
Lead (Pb)	0.54 to 2.1 µg/L	0.54 to 2.1 µg/L
Manganese (Mn)	0.5 to 0.7 mg/L	0.07 to 0.6 mg/L
Zinc (Zn)	5.5 to 8.0 mg/L	<0.005 to 6.1 mg/L

The apatite treatment system generally resulted in the following changes to adit water chemistry:

- change from oxidizing to reducing (or less oxidizing) conditions;
- reduction in trace metal concentrations (Cd and Zn);
- reduction in Fe and Mn concentrations;

- small increase in Ca concentrations;
- increase in sulfide concentrations;
- increase in nutrient concentrations (N and P); and,
- increase in total coliform concentrations.

The following sections describe these changes in more detail.

pH. In general, very little change in pH was observed between the influent and effluent (Fig. 4). Influent pH between November 2002 and May 2003 exhibited little variability, ranging from 6.6 to 7.0. Between May and August 2003, influent pH demonstrated a decreasing trend, from near neutral (6.6) to slightly acidic (5.3). Influent pH increased throughout the fall of 2003, remaining stable over the winter months at levels comparable to the winter of 2002 (i.e., pH values from 6.1 to 6.7). In 2004, pH reached a minimum in April/May, reporting levels slightly below 6. The pH of the effluent was very stable, typically ranging from approximately 6 to 7.

The alkalinity of effluent waters was also generally similar to alkalinity in the influent (Fig. 4). Port 4 typically reported higher alkalinity (up to approximately 30 mg/L) than Ports 2 and 3. The greatest differences in outflow alkalinity between Port 4 and Ports 2 and 3 were observed during the early stages of monitoring (March to October 2003) and in the final stages of monitoring (May to August 2004).

Redox Condition. The influent was slightly oxidized, as indicated by positive Eh values (ranging from 160 to 320 mV) (Fig. 4) and the presence of dissolved oxygen (6 to 11 mg/L). Low levels of ammonia (up to 0.2 mg/L) and sulfide (typically less than 0.5 mg/L) have been recorded at Port 1.

The Eh of the outflow during the first year of monitoring indicated a change toward more reducing conditions, ranging from -90 to 230 mV. A decline in dissolved oxygen and increases in ammonia and sulfide concentrations were also indicative of more reducing conditions within the treatment tank in comparison to the influent. Since November 2003, differences between influent and effluent Eh were generally smaller, and in some months, effluent Eh values were higher than influent Eh. Port 4 in the final stages of monitoring was an exception, reporting lower Eh values than both the influent and Ports 2 and 3. Over the period of monitoring, a general decline in effluent sulfide concentrations was observed. Air sparging did not appear to affect effluent Eh values, that is to say, an increase in Eh was not consistently observed following air sparging events.

Comparison of the three outflow water qualities indicated variability in the redox condition among tanks. Although the effluent showed a decline in dissolved oxygen relative to the influent, since May 2003, greater reductions in dissolved oxygen were typically observed in Ports 2 and 4 than in Port 3. Throughout 2003, Port 4 consistently recorded the highest sulfide concentrations (Fig. 5). On the basis of sulfide content, Port 4 would be characterized as the most reducing tank throughout 2003. Higher alkalinity in Port 4 outflow during the first year of monitoring is consistent with more reducing conditions in this tank. The 2004 outflow monitoring results between February and April 2004 showed relatively low sulfide concentrations for all tanks ranging from below detectable limits (<0.5 mg/L) to 2 mg/L. Since May 2004, sulfide levels in Port 4 increased, consistent with declines in Eh values.

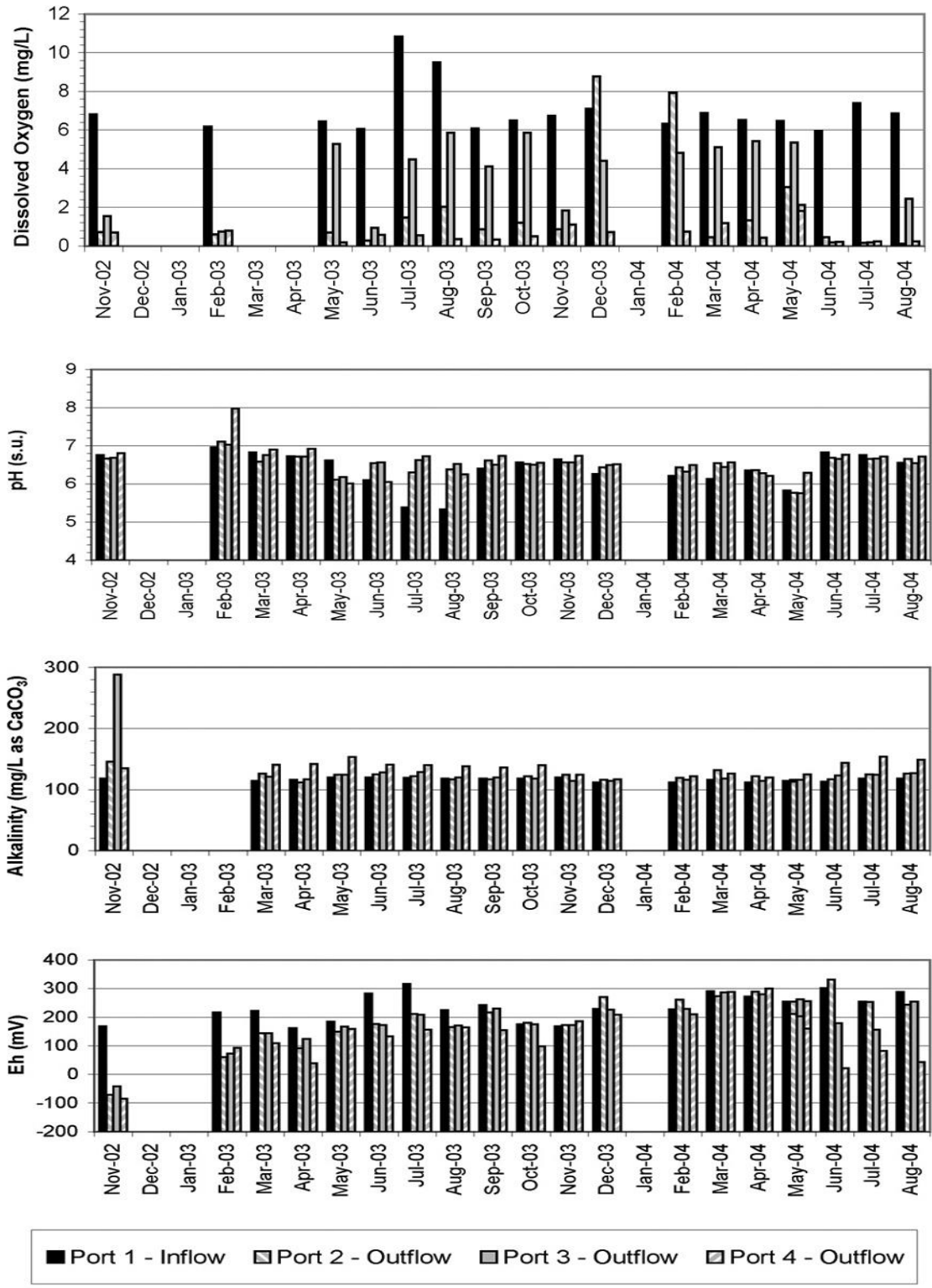

Figure 4: Treatment Tank Dissolved Oxygen, pH, Alkalinity and Eh

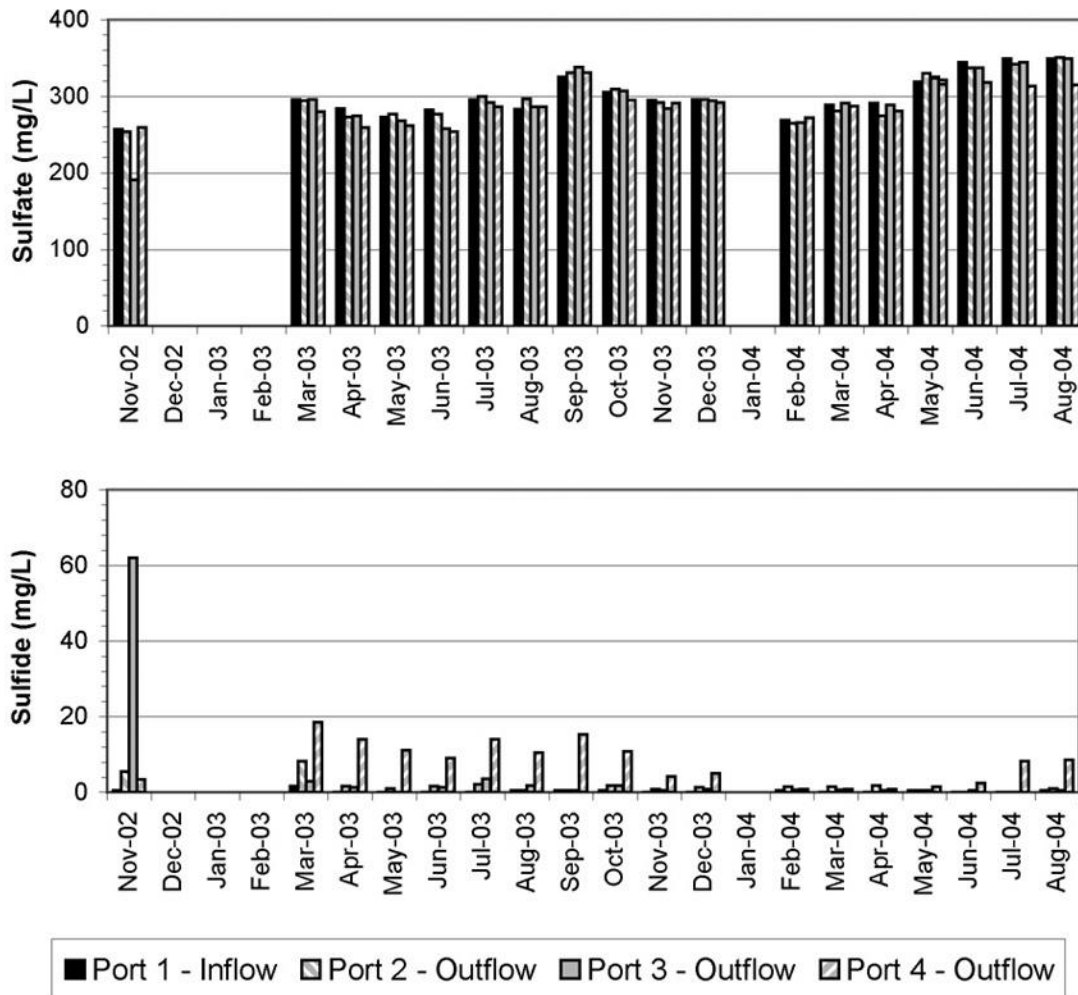

Figure 5: Treatment Tank Sulfate and Sulfide Concentrations

Differences in outflow Fe and Mn concentrations also suggest variability in redox conditions. Declines in dissolved Fe and Mn were observed at all outflows; however, the magnitude of these declines was variable. Dissolved Fe and Mn concentrations were generally higher in Port 3 than Ports 2 and 4, indicating a lesser degree of attenuation (Fig. 6).

Figure 7 shows average concentrations of redox species concentrations for all Ports from May through December 2003 (i.e., O₂, N, Fe, Mn and S). This figure illustrates the variability in redox conditions among tanks. Throughout 2003, Port 4 was the most reducing, reporting the lowest average dissolved oxygen and highest sulfide and ammonia concentrations. Data for Ports 2 and 3 indicated more oxidized environments. Port 4 average sulfide and ammonia concentrations in early 2004 were similar to those in Port 2, suggesting less variability in redox conditions between these tanks. A shift to less reducing conditions in the tanks over time would be consistent with the degradation and depletion of organic material through time. The most recent data for Port 4 show a shift back toward more reducing conditions in this tank.

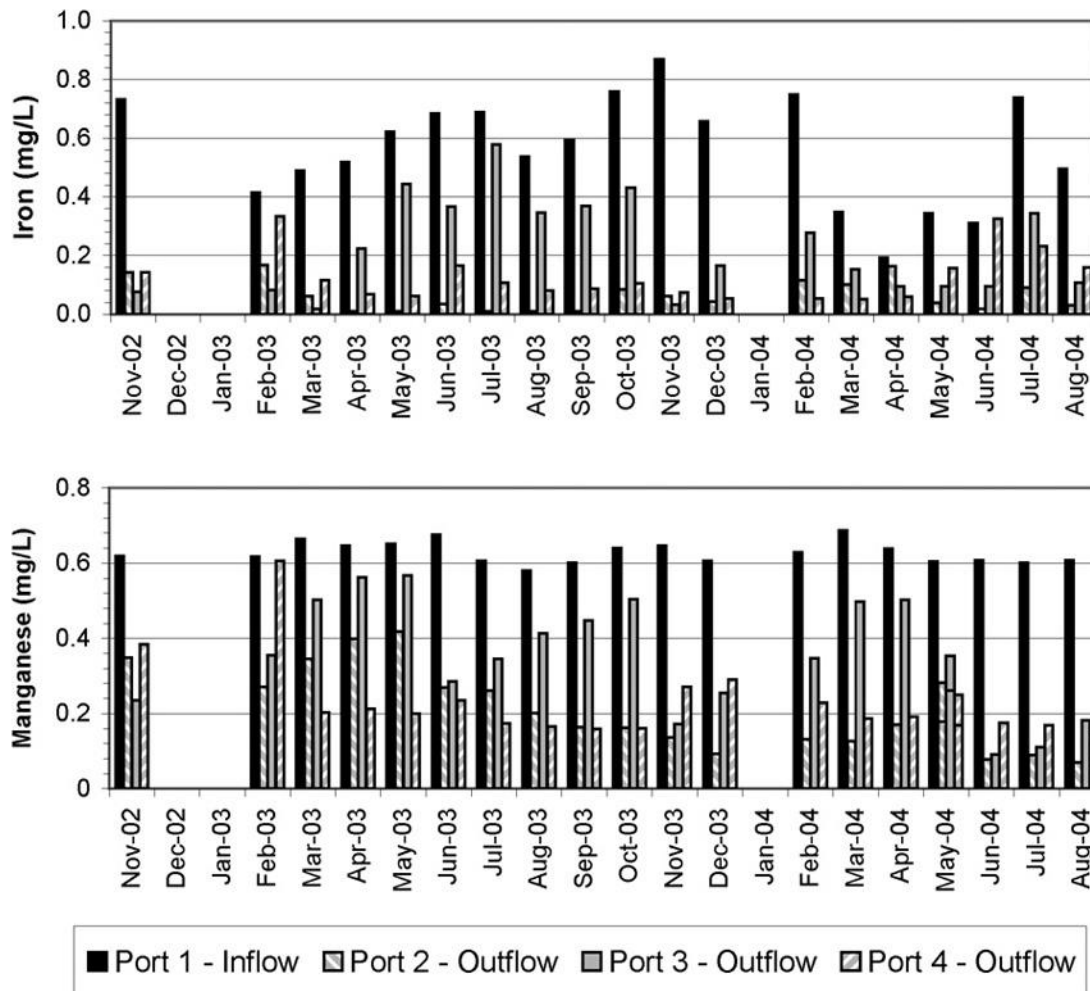

Figure 6: Treatment Tank Fe and Mn Concentrations

SRB results from September 2004 also indicate variable redox conditions among tanks (Table 3). SRB concentration trends among ports were consistent with trends in sulfide data from the August 2004 sampling event. Variability in the redox condition is likely in part attributed to differences in the flows among the tanks.

Major Ions. Calcium concentrations in the influent were relatively stable, ranging from 83 to 103 mg/L. Effluent waters reported slightly higher Ca concentrations, up to 111 mg/L (Fig. 8). Monitoring results show little difference between influent and effluent Mg concentrations on a monthly basis (typically less than 1 mg/L). The observed declines in SO_4^{2-} concentrations between the influent and effluent (Fig. 5) generally correlated with increases in sulfide concentrations. On a monthly basis, the sample Port that reported the greatest decline in SO_4^{2-} , typically recorded the highest sulfide concentration (Fig. 5).

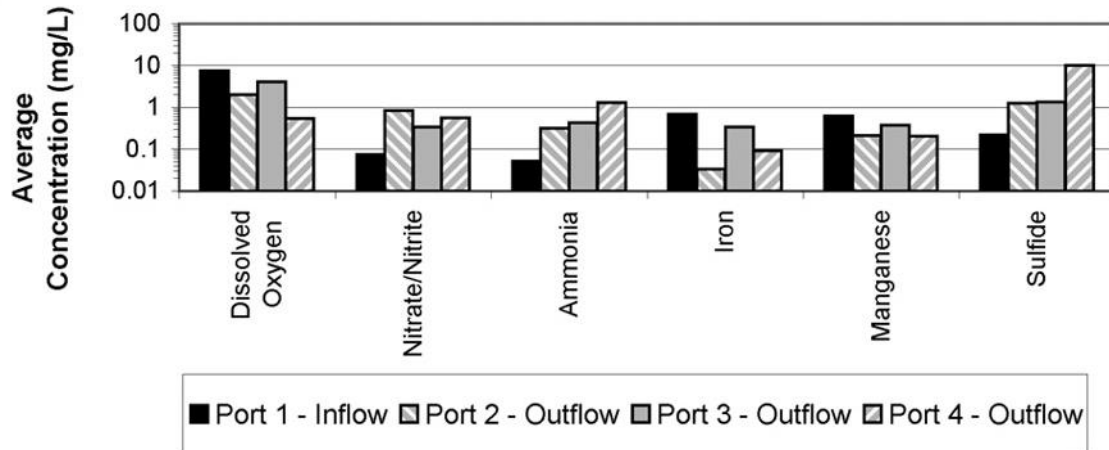

Figure 7: Treatment Tank Redox Constituents (May to December 2003)

Table 3. Sulfate Reducing Bacteria Monitoring Results

	Sulfate Reducing Bacteria (SRB) (MPN/mL)^a	Sulfide (mg/L)
Date	9/28/2004	8/17/2004
Port 1	<1.8	0.5
Port 2	20	0.95
Port 3	<1.8	0.59
Port 4	78	8.6

^aMPN/mL – most probable number per milliliter

Metals. The treatment system appears to effectively attenuate Zn (Fig. 9). Since March 2003, Port 4 demonstrated the greatest removal efficiency (i.e., reported the lowest outflow Zn concentrations). Between March and November 2003, dissolved Zn concentrations were reduced from ppm levels to less than 15 ppb. Between November 2003 and April 2004, Port 4 effluent Zn concentrations gradually increased, coincident with a change to more oxidizing conditions (i.e., a reduction in effluent sulfide concentrations). A return to more reducing conditions in the final months of monitoring (i.e., an increase in sulfide concentrations) resulted in a decline in effluent Zn concentrations. The effectiveness of Zn removal at Port 2 decreased through time. Zinc in this treatment tank during the early stages of monitoring was reduced to the 10s of ppb level. Since May 2003, Port 2 Zn concentrations ranged from 0.5 to 5 mg/L. Port 3 showed the least Zn attenuation, with outflow Zn concentrations ranging from 1 to 6 mg/L since February 2003.

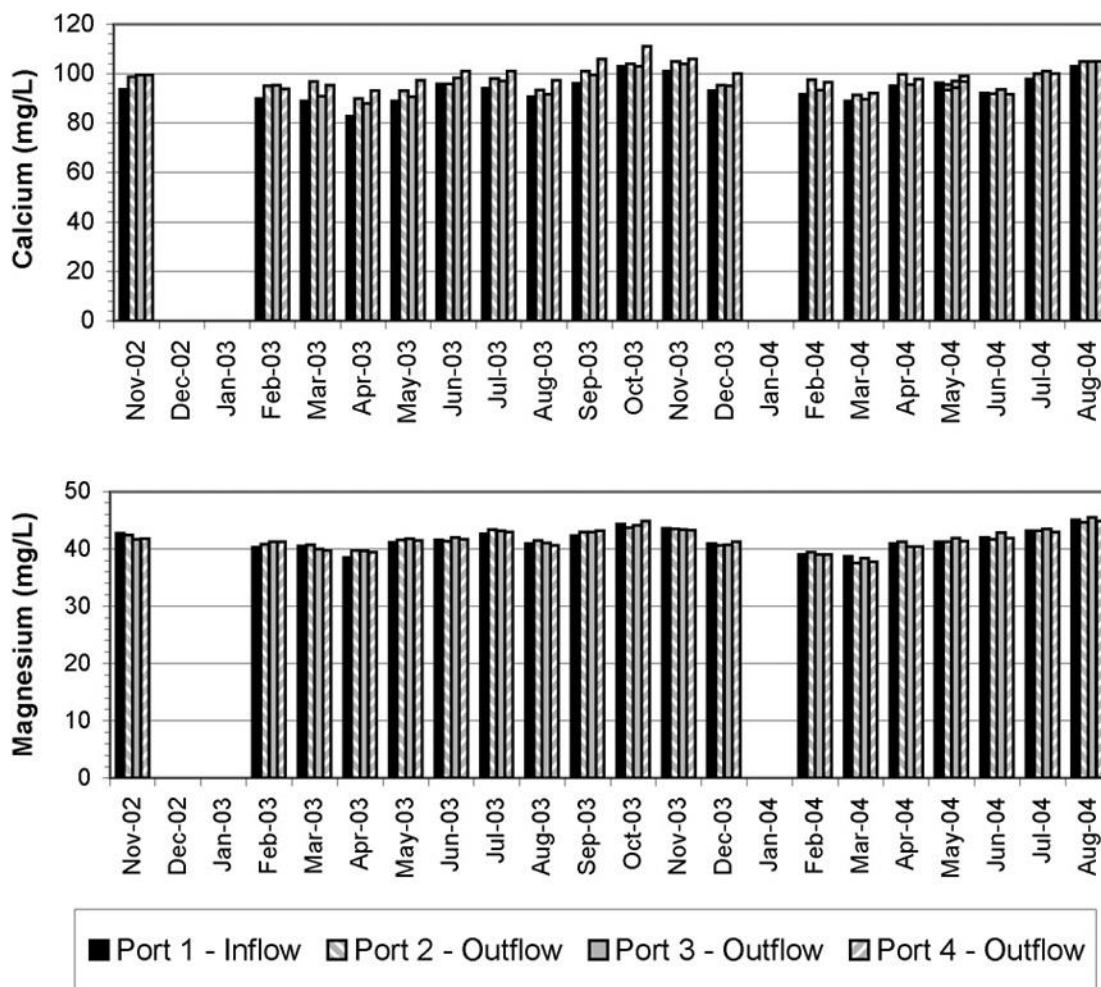

Figure 8: Treatment Tank Ca and Magnesium Concentrations

A decline in Cd concentrations was also observed; however, influent dissolved Cd concentrations were very low (< 1 ppb) resulting in very small absolute reductions in concentration (Fig. 9). Influent Cd concentrations appear to vary seasonally, with peak concentrations measured in the winter and minimum concentrations measured in the summer.

No significant differences in dissolved Pb concentrations were observed between influent and effluent concentrations (Fig. 9). On some dates (e.g., March, April, June and July 2003) the effluent ports reported slightly higher Pb concentrations than the influent. Similar to Cd, influent dissolved Pb concentrations were very low (less than 3 ppb).

Attenuation of Fe and Mn within the ATS was observed as well (Fig. 6). Influent Fe concentrations ranged from 0.2 to 0.9 mg/L. The three tanks showed varying degrees of Fe attenuation. Outflow Fe concentrations ranged from below detectable limits (<0.01 mg/L) to 0.6 mg/L. Manganese in the influent was stable at 0.6 to 0.7 mg/L. Manganese in the effluent ranged from 0.1 to 0.6 mg/L.

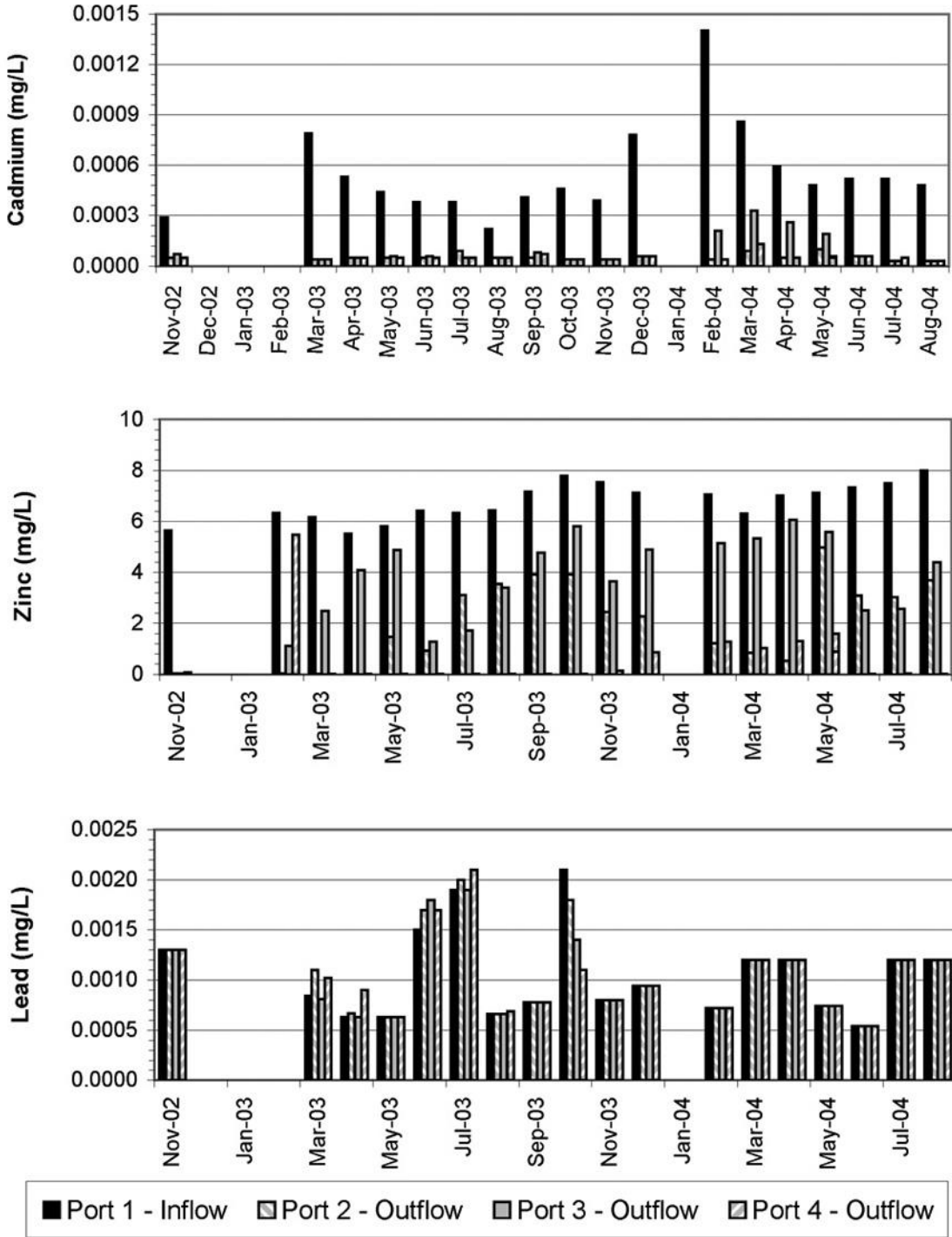

Figure 9: Treatment Tank Cd, Zn and Pb Concentrations

Nutrients. Characteristic of apatite treatment systems, an increase in P concentrations was observed in the effluent (Fig. 10). Total N in the effluent was higher than in the influent,

indicating N release from the treatment medium (Fig. 10). Collagen is considered the most likely N source.

Bacteriological. Influent total coliform concentrations typically ranged from below detectable limits (< 1 per 100 mL) to less than 10 per 100 mL. An increase in total coliform was generally observed between the influent and the effluent (only three sampling events at Port 4 reported a decline in total coliform). Peak outflow total coliform was measured in June 2003 at 467 per 100 mL¹. Port 4 total coliform levels generally declined over the period of monitoring.

Retention Basin Water Quality Results

Port 1 and Port A are located at the inflow and the outflow of the retention basin, respectively (Fig. 1). The retention basin outflow quality (Port A) was similar to the inflow (Port 1). Very little change was observed in pH (< 0.2 pH units) and conductivity (<5 µS/cm) between the retention basin inflow and outflow. A slight decline in Fe concentrations was consistently observed, possibly due to the precipitation of Fe oxyhydroxides. Small declines in Zn concentrations were observed on two out of three dates samples were collected at Port A and Port 1. The retention basin results in only minor changes to the dissolved phase inflow chemistry to the three apatite treatment tanks.

Solid Phase Results

Elemental Composition. Solid phase chemistry results are shown in Fig. 11. Solid phase Cd, Fe, Mn, and Zn concentrations are higher in the treatment tank in comparison to the raw fish bone samples, indicating retention of these constituents within the treatment tank. These results were expected based on the observed reduction in aqueous phase concentrations between the inflow and outflow. Although little change was observed between inflow and outflow aqueous Pb concentrations (Fig. 9), the solid phase results indicate retention of Pb within the treatment tank.

The raw fish bone has an average magnesium content of 0.32 wt. %. The average Mg content of the treatment tank samples declined from 0.25 wt. % in July 2003 to 0.12 wt. % in September 2004. The observed decrease in solid phase Mg concentrations indicates dissolution of a Mg-bearing phase within the treatment tank, most likely the fish bone. Release of magnesium has also been observed for the Success apatite treatment system (Golder Associates, 2003).

The raw fish bone mixture has a Ca content of approximately 20 wt. %. The average Ca content of samples collected from the three treatment tanks in July 2003 ranged from 20 to 22 wt. %. These results suggest that Ca released by the dissolution of apatite is re-precipitated (or sorbed) within the treatment tanks. The September 2004 results show a decline in the average Ca content of all treatment tanks, ranging from 11 to 13 wt. %. These results indicate release of Ca from the treatment tank.

¹ In March 2003, April 2003 and July 2004 Port 4 total coliform was reported by the analytical laboratory as “too numerous to count” (TNTC).

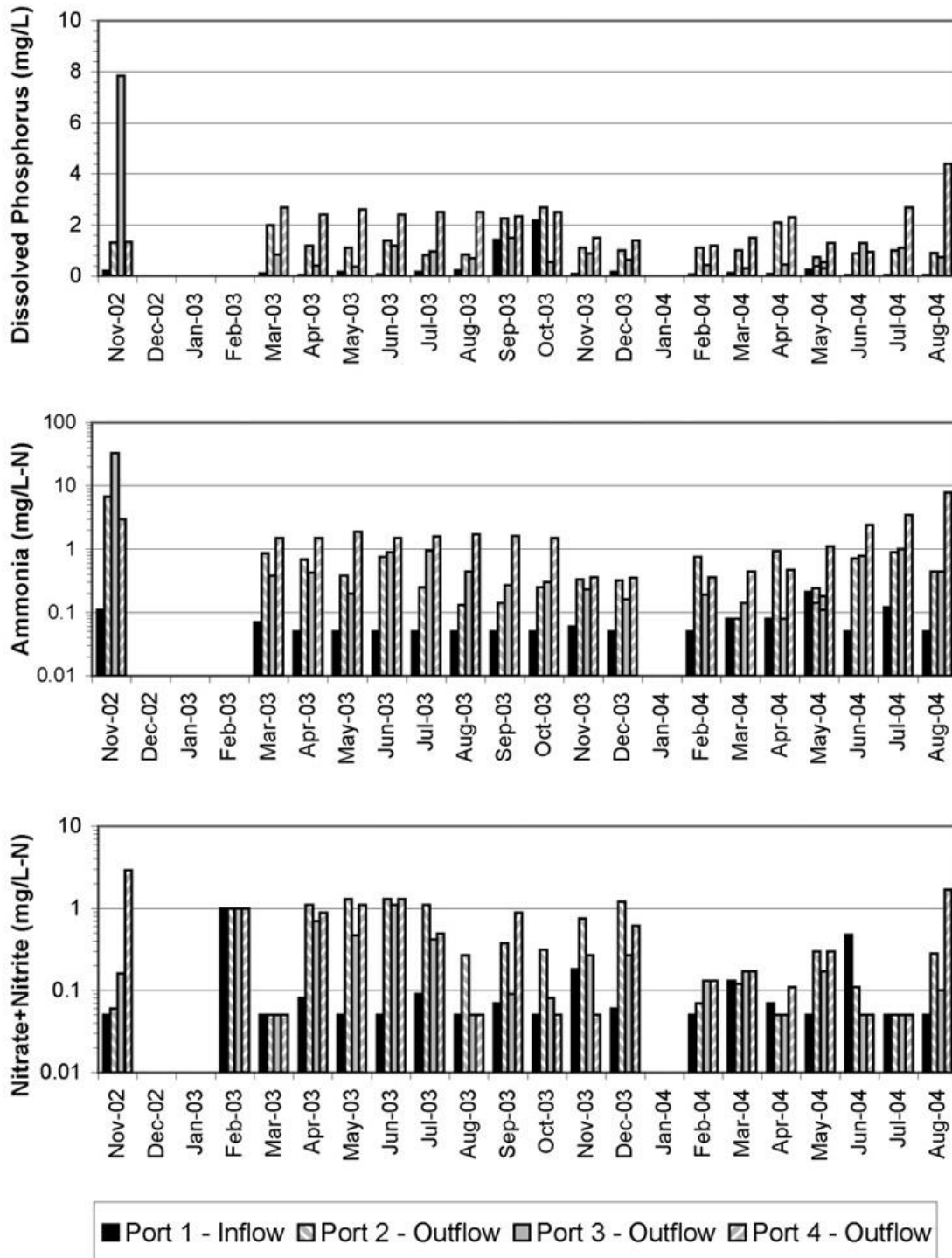

Figure 10: Treatment Tank Dissolved Phosphorus, Ammonia and Nitrate+Nitrite Concentrations

The solid phase results further suggest spatial variability in the degree of metals attenuation throughout the tanks. For example, solid phase Cd, Fe, Mn, and Pb concentrations all peaked at a depth of 8 inches within treatment Tank 3 in July 2003. In September 2004, a distinct peak in these same constituents was observed at surface in Tank 2. Spatial variability in the degree of

attenuation throughout the tanks likely results from both chemical variability (e.g., spatial variability in redox conditions) as well as physical variability (e.g., preferential flow paths). Due to the small mass of sample subjected to total metals analysis (on the order of a few grams), observed peaks in trace metal concentrations may simply represent a micro-environment within the treatment tank. For this reason, an evaluation of average solids concentrations is likely more indicative of overall conditions and trends within the treatment tanks.

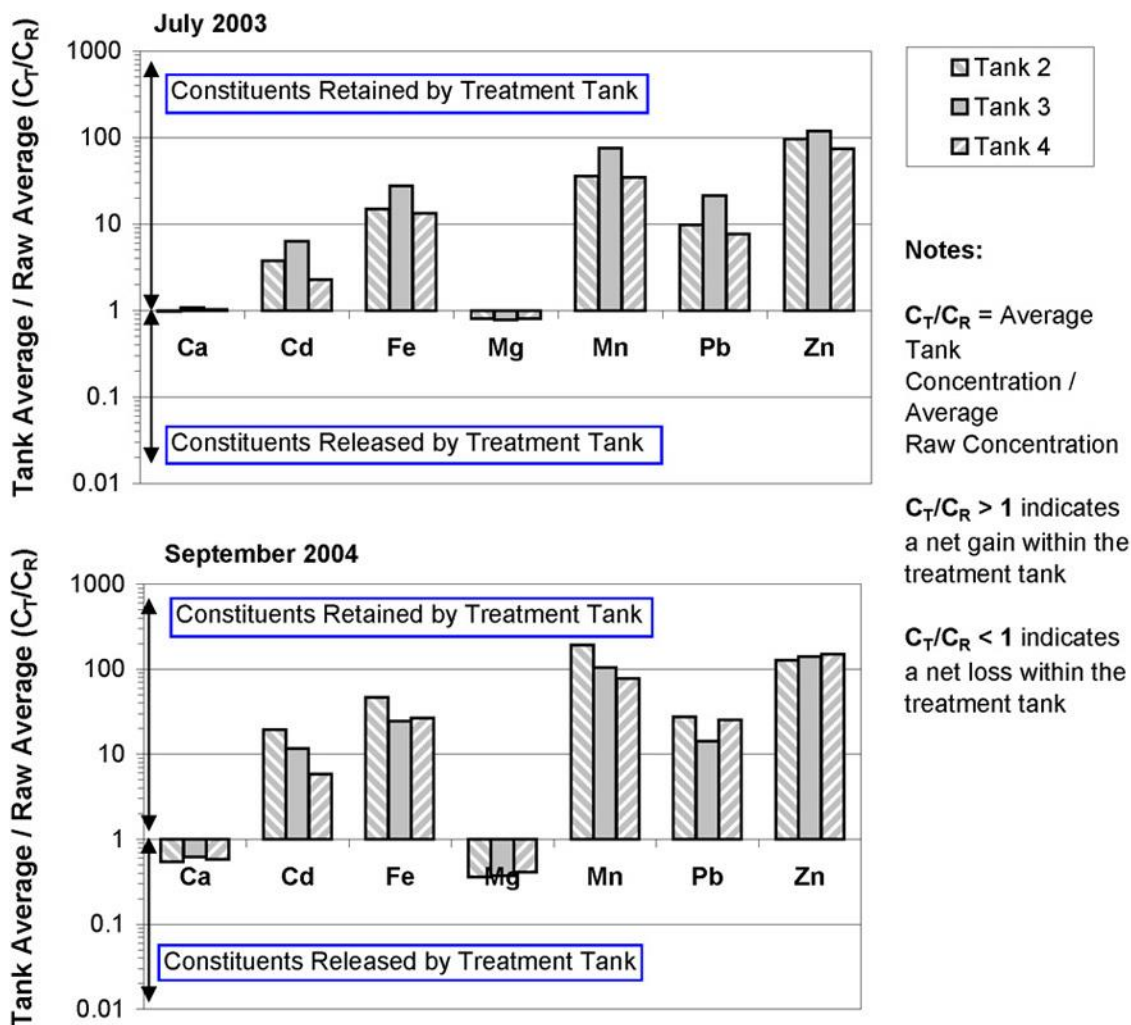

Figure 11: Treatment Tank Solids Metal Concentrations

Pearson correlation analysis was conducted to evaluate the correlation among metals within the treatment tank solids, as this may provide insight into the identification of attenuation mechanisms within the tanks.

The September 2003 and July 2004 data sets were combined for correlation analysis. Correlation results indicate a strong positive correlation between Fe and Pb ($r = 0.92$), Cd ($r = 0.87$) and Mn ($r = 0.98$). Scatter plots of Fe versus Pb, Mn and Cd confirm a strong linear relationship. Positive correlations are also observed between Mn and Cd ($r = 0.90$), Mn and

Pb ($r = 0.87$) and Cd and Pb ($r = 0.74$). These results suggest that these constituents (i.e., Mn, Fe, Cd and Pb) are attenuated by the same geochemical process. Overall, Zn showed a poor correlation with Fe ($r = 0.16$), Cd ($r = 0.27$), Mn ($r = 0.14$) and Pb ($r = 0.24$) suggesting that the attenuation mechanism for Zn is distinct from that for the other constituents.

Mineralogical Analysis. Montana Tech used both XRD and SEM/EDX techniques to evaluate the mineralogy of the raw fish bone and treatment tank samples. XRD will identify crystalline phases present in a sample above the method's quantitation limit, generally a few percent. Poorly crystalline HA was the only phase identified by XRD (Clary, 2004).

SEM/EDX analysis of the solids from all treatment tanks showed high Zn concentrations in association with high sulfide. Zinc sulfide crystals were identified in samples from treatment Tank 4. The exact nature of the ZnS_2 crystals (e.g., sphalerite, wurtzite) was not determined. Identification of Cd and Pb phases was hindered by the relatively low concentrations of these metals (Clary, 2004).

Geochemical Modeling

Geochemical modeling was conducted to identify possible reaction mechanisms responsible for changes in observed constituent concentrations. The geochemical model used was PHREEQC Version 2.7 (Parkhurst and Appelo, 1999), an equilibrium speciation and mass-transfer code developed by the United States Geological Survey (USGS). This model has the ability to simulate mixing of waters, precipitation/dissolution of selected solids, redox reactions, atmospheric interaction and adsorption of metals onto Fe oxides. The fast reaction kinetics of HA dissolution (Xu and Schwartz, 1994) supports the application of an equilibrium model. The MINTEQA2 thermodynamic database was used in this study.

Speciation Modeling

Speciation modeling was conducted for all monitoring results for which a comprehensive chemical analysis was available (i.e., major ions and trace metals) at the following monitoring locations: Adit, ATS inflow (Port 1) and ATS outflows (Ports 2, 3 and 4). Model result evaluation focused on the constituents listed in Table 4 for which the greatest changes in concentration were observed.

Table 4. Constituents Retained and Released by the ATS Treatment System.

Net Increase in Concentration (Treatment Tank = Source)	Net Decline in Concentration (Treatment Tank = Sink)
Calcium (Ca)	Iron (Fe)
Phosphorus (P)	Manganese (Mn)
Nitrogen (N)	Zinc (Zn)

To evaluate possible controlling mineral phases, inflow and effluent water chemistries were speciated and saturation indices evaluated. Concentrations of constituents reported as below

detectable limits were assumed equal to the detection limit. The potential for mineral precipitation was assessed using the saturation index (SI) calculated according to Equation 4.

$$SI = \log (IAP/K_{sp}) \quad (4)$$

The saturation index is the ratio of the ion activity product (IAP) of a mineral and the solubility product (K_{sp}). An SI greater than zero indicates that the water is supersaturated with respect to a particular mineral phase and therefore, mineral precipitation may occur. Conversely, an SI less than zero suggests a propensity for a particular mineral to dissolve. Supersaturated mineral phases were identified and evaluated for their likelihood to precipitate from the solution. Near-saturation is defined as $-0.5 \leq SI \leq +0.5$. This range was used to account for uncertainties in the thermodynamic database, as well as uncertainties inherent to collection and analysis of water samples.

Iron. SI values in treatment tank inflow water often indicated near-saturated conditions with respect to ferrihydrite [$Fe(OH)_3$]. Precipitation of ferrihydrite is consistent with observations of Fe staining at the adit. The treatment cell effluent, however, was generally undersaturated with respect to ferrihydrite.

Precipitation of FeS_2 may be responsible for the observed decline in Fe concentrations between the influent and the effluent. Equilibrium with respect to FeS_2 was observed during simulation of many effluent solutions at Port 4 and during the early stages of monitoring at Port 2. Pyrite [FeS_2] was supersaturated in all modeled solutions due to the presence of detectable dissolved sulfide.

Equilibrium with the Fe phosphate strengite [$FePO_4 \cdot 2H_2O$] was predicted at times within all tanks. Vivianite [$Fe_3(PO_4)_2 \cdot 8H_2O$] was modeled to be undersaturated in the effluent. Strengite and vivianite have been proposed as controls on PO_4^{3-} concentrations downstream of septic systems (Zanini et al., 1998; Carodona, 2000). Precipitation of a pure Fe phosphate may therefore be a control on Fe concentrations; however, Fe substitution within a Ca phosphate phase (e.g., HA) also may occur.

Calcium and Phosphorus. The influent (Port 1) was modeled to be at near-saturation with respect to HA during the early stages of monitoring. Since June 2003, SI values for HA typically indicated undersaturated conditions. Effluents were generally supersaturated with respect to HA, indicative of dissolution of this mineral within the treatment tank. Bostick and others (2000) note that Apatite IITM is more soluble than crystalline HA, consistent with the model's prediction of supersaturation with respect to HA. Observed increases in aqueous Ca and P are consistent with dissolution of HA.

Zinc. Effluents were undersaturated with respect to the Zn carbonate, hydroxide, sulfate and phosphate minerals included in the MINTEQA2 database. Equilibrium with respect to the Zn sulfide wurtzite [ZnS] was predicted in Port 2 and 4 waters on occasion, suggesting a control on Zn concentrations through mineral precipitation. Its polymorph sphalerite [ZnS] was modeled to be supersaturated in both the influent and effluents due to the presence of detectable dissolved sulfide in both. Mineralogical analysis by Montana Tech has identified Zn sulfide as a secondary mineral phase (Clary, 2004). A plot of effluent Zn versus sulfide shows lower Zn concentrations in association with higher sulfide, consistent with greater Zn attenuation under reducing conditions (Fig. 12 – note the logarithmic scale on the ordinate).

Manganese. The effluents were undersaturated with respect to the Mn carbonate, hydroxide, and oxide minerals included in the MINTEQA2 database. The effluents were near equilibrium to supersaturated with respect to Mn phosphate [MnHPO₄]. Attenuation of Mn within the treatment tank may therefore be attributed to the precipitation of a Mn phosphate; however, further evaluation would be required to establish if MnHPO₄ is indeed a credible secondary mineral phase. Adsorption onto ferrihydrite within the retention-settling basin may also account for Mn attenuation. Within the apatite treatment tanks where conditions are more reducing, adsorption onto ferrihydrite is considered an unlikely mechanism for Mn removal.

Nitrogen. As mentioned earlier, N release from the treatment tank is likely attributed to collagen. Attenuation of nitrogen by mineral precipitation is considered unlikely.

Aqueous/Solid Phase Interaction Modeling

The second phase of the geochemical modeling effort involved simulation of interactions between the solid and aqueous phase. Possible controlling mineral phases identified during speciation modeling were equilibrated with the influent. The goal of this modeling was to assess the model's ability to predict effluent water quality using the standard thermodynamic database.

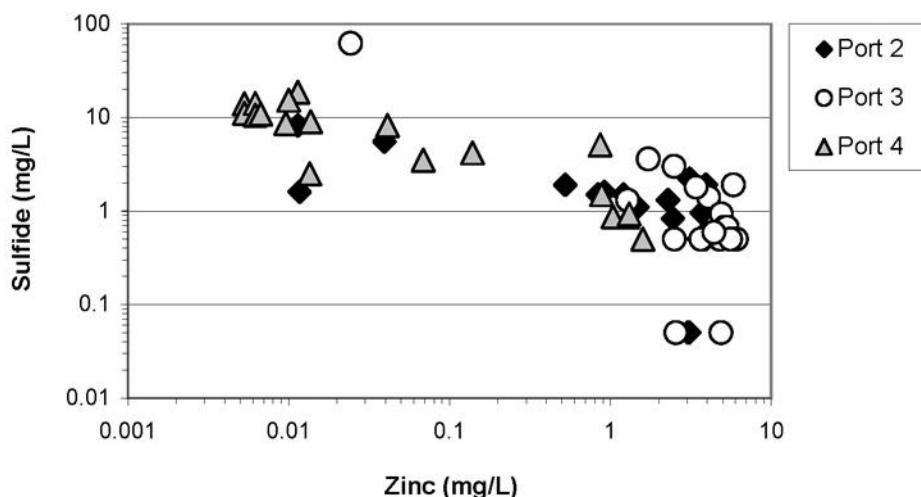

Figure 12: Treatment Tank Effluent Zn Versus Sulfide

Model Approach. For selected sampling dates, the influent chemistry (Port 1) was equilibrated with selected geochemically-credible solid phases. The resultant chemistry was then compared to measured outflow water qualities (Ports 2, 3 and 4). Specifically, the following stepwise approach was followed:

1. Settling Pond - Port 1 water quality was equilibrated with ferrihydrite, meaning that if ferrihydrite was supersaturated, this mineral phase was allowed to precipitate. When ferrihydrite was predicted to precipitate, adsorption of metals onto this mineral phase was simulated.
2. Treatment Tank - Outflow water quality from Step 1 was equilibrated with HA [Ca₅(PO₄)₃OH]. Collagen was added to solution based on the amount of nitrogen released from the treatment tank calculated as the difference between influent and

effluent total nitrogen concentrations. The following credible mineral phases were allowed to precipitate if supersaturated: MnHPO_4 , calcite [CaCO_3], gypsum [$\text{CaSO}_4 \cdot 2\text{H}_2\text{O}$], galena [PbS], sphalerite [ZnS], wurtzite [ZnS] and greenockite [CdS].

3. Comparison – Predicted outflow water quality was compared to inflow water quality.

The model did not simulate adsorption of metals onto HA. Only adsorption onto freshly precipitated ferrihydrite was considered. Biological reactions within the treatment tank were also not represented in the modeled system.

Model Results. Comparisons of measured and simulated treatment tank water qualities for the April 2003 data set are provided in Table 5. Port 1 measured water quality is representative of the water entering the settling pond (Tank 1). Port 1 outflow water quality is the predicted water quality following equilibration with ferrihydrite and metal adsorption onto this phase. These water qualities are therefore not directly comparable.

The model simulation predicts precipitation of ferrihydrite within the settling tank. This results in a decline in aqueous Fe concentrations to values below those measured in treatment tank outflows suggesting possible overprediction of ferrihydrite precipitation by the model. Adsorption of Zn, Pb, Ca, phosphate, sulfate, Mn and Cd onto the freshly precipitated ferrihydrite is predicted as well. Reductions in concentration for all constituents through adsorption are predicted to be small, ranging from less than 1 ppb (e.g., Cd and Pb) to 10s of ppb (e.g., Zn).

Precipitation of MnHPO_4 and Cd, Pb and Zn sulfides is predicted within the treatment tanks. For all four constituents (i.e. Mn, Cd, Pb and Zn), the model overpredicts the degree of attenuation within the treatment tank. Discrepancies between modeled and measured concentrations may be attributed to any one or a combination of the following:

1. The model simulation assumes equilibrium conditions, and therefore, does not account for the kinetics of precipitation reactions, which may result in slower formation of mineral precipitates.
2. The model assumes precipitation of pure mineral phases. In reality, most mineral phases formed will contain significant amounts of impurities. The presence of such impurities affects the thermodynamic properties and solubility characteristics of the minerals.
3. Incorrect identification of controlling mineral phases and/or a lack of thermodynamic information on minerals present in the tanks.

Good agreement is observed between the measured and modeled pH and redox conditions within the treatment tanks. The model accurately simulates the observed increases in alkalinity between inflow and outflow waters. This increase in alkalinity is attributed to the dissolution of HA, which releases phosphate ions into solution, and redox reactions (i.e., sulfate reduction by organic matter). Under prediction of outflow total P may be attributed to an underestimation of the amount of HA that dissolves or due to overestimation of the precipitation of MnHPO_4 .

Simulated release of collagen from the treatment medium results in a change from oxidizing to reducing conditions. The model therefore reasonably simulates the distribution of sulfur between sulfate and sulfide. The model returns lower pe values for the treatment tanks than those recorded in the field. The occurrence of both nitrate+nitrite and sulfide in treatment tank outflows suggests a state of redox disequilibrium within the tanks. The ability to simulate a

change from oxidizing to more reducing conditions, as observed in the field, is considered more important than obtaining an exact match between measured and modeled pe values.

Table 5. Comparison of Model Results to Measured Concentrations.

Constituent	Port 1	Port 1	Port 2 Outflow		Port 3 Outflow		Port 4 Outflow	
	Inflow	Outflow	Actual	Model	Actual	Model	Actual	Model
pH (s.u.)	6.73	6.72	6.72	6.74	6.72	6.71	6.92	6.77
pe (s.u.)	2.9	7.0	1.6	-2.9	2.2	-2.8	0.7	-2.9
Alkalinity (mg/L)	116	115	112	133	117	126	142	143
Ca (mg/L)	82.7	82.7	89.8	83.6	87.9	83.6	93.0	83.5
Cd (mg/L)	0.00053	0.00053	0.00005	<0.00001	0.00005	<0.00001	0.00005	<0.00001
Fe (mg/L)	0.52	0.002	0.01	0.002	0.22	0.002	0.07	0.002
Mn (mg/L)	0.65	0.65	0.40	0.03	0.56	0.02	0.21	0.03
N (mg/L)	0.13	0.13	1.8	1.8	1.1	1.4	2.4	2.5
P (mg/L)	0.05	0.03	1.20	0.09	0.40	0.10	2.40	0.08
Pb (mg/L)	0.0006	0.0004	0.001	<0.0001	0.001	<0.0001	0.001	<0.0001
SO ₄ ²⁻ (mg/L)	284	284	273	266	274	271	259	259
S ²⁻ (mg/L)	0.1	0.0	1.6	3.3	1.4	1.6	14	5.7
Zn (mg/L)	5.52	5.50	0.010	0.0003	4.08	0.0002	0.010	0.0005

Summary and Conclusions

Geochemical Modeling

An extensive geochemical data set is available for the Nevada Stewart ATS. This system effectively attenuates Cd, Zn, Fe and Mn as evidenced by decreases in aqueous phase concentrations between the influent and the effluent and increases in the solid phase concentrations of these constituents within the treatment tanks. An increase in solid phase Pb concentrations within the treatment tanks suggests Pb attenuation.

Geochemical modeling was conducted to identify possible attenuation mechanisms for Cd, Mn and Zn. Speciation modeling was first conducted to assess the potential for mineral precipitation. Speciation modeling identified Mn phosphate as a possible control on Mn concentrations. Depending on the redox conditions within each treatment tank, precipitation of ferrihydrite, Fe sulfide or Fe phosphate may control Fe concentrations. Supersaturation was observed with respect to a number of metal sulfides (i.e., Cd, Pb and Zn).

The second phase of geochemical modeling involved simulation of the aqueous and solid phase interactions within the treatment tanks. These simulations showed good agreement between the measured and modeled geochemical conditions within the treatment tanks (e.g., pH, redox and alkalinity). Simulated release of collagen from treatment media resulted in a redox change within the treatment tanks from oxidizing to reducing conditions, as observed in the field. The chemical characteristics of the organic component of the reactive medium (tentatively identified and modeled as collagen) may merit further investigation, as its dissolution appears to have a pronounced effect on effluent quality. Good agreement was observed between modeled and observed sulfur speciation within the treatment tank. Simulated precipitation of MnHPO_4 and metal sulfides (i.e., CdS , PbS , and ZnS) resulted in an over prediction of metal attenuation by the treatment tank.

Attenuation can likely be attributed to a variety of mechanisms including both mineral precipitation and surface reactions (e.g., adsorption). The results of geochemical modeling were reviewed in the context of the entire data set (i.e., solid phase analysis and mineralogy) and experience at other sites to identify the most likely attenuation mechanisms.

Attenuation Mechanisms

Sulfide Mineral Precipitation. Precipitation of Zn sulfide is likely the dominant mechanism for Zn attenuation within the treatment tanks. Some Fe attenuation within the treatment tanks (in particular Tank 4) may also be attributable to the precipitation of an Fe sulfide. The treatment of acid mine drainage with permeable reactive barriers (PRBs) that attenuate metals by sulfide precipitation has proven successful (Benner et al., 1997). In such treatment systems, reducing conditions are created (e.g., through use of organic substrates), resulting in formation of insoluble metal sulfides. The reducing conditions in the Nevada Stewart ATS, specifically the presence of hydrogen sulfide, suggest that metal attenuation through sulfide precipitation may also be occurring at the Nevada Stewart Site. The aqueous chemistry results support removal of Zn under reducing conditions. The lowest effluent Zn concentrations occur in association with elevated sulfide concentrations. Mineralogical evaluation, however, is the best way to conclusively identify controlling secondary mineral phases. Mineralogical analysis by Montana Tech confirmed the presence of a Zn sulfide (Clary, 2004).

Attenuation of Cd and Pb due to sulfide precipitation is inconclusive. Speciation modeling showed supersaturation with respect to both Cd and Pb sulfide. The relatively low solid phase concentrations of these metals in the treatment tanks prevented the identification of any Cd/Pb secondary mineral phases by Montana Tech (Clary, 2004). Correlation analysis results for the treatment tank elemental concentrations suggest an alternative attenuation mechanism to sulfide precipitation. If the dominant mechanism for Cd and Pb removal was sulfide precipitation, a correlation between Zn and these metals would be expected. Although the early solid phase chemistry results do show a correlation between Cd and Zn, a positive correlation was not observed for the September 2004 data set.

Phosphate Mineral Precipitation. Speciation modeling identified Mn phosphate as a possible control on Mn concentrations. Further evaluation would be required to establish if MnHPO_4 is indeed a credible secondary mineral phase. Similarly, formation of strengite (Fe-phosphate) was identified as a possible sink for Fe.

Effluent saturation indices indicate undersaturation with respect to HP. Because influent Pb concentrations are very low, substitution of Pb for Ca during re-precipitation of HA may be the

mechanism responsible for Pb attenuation. Precipitation of CP, which has a lower solubility than HP or HA (Fig. 2), may also control Pb concentrations. On the dates for which Cl⁻ data were available, saturation indices for this mineral were calculated. Chloride concentrations were generally below or close to the detection limit in site waters. The inflow was undersaturated with respect to CP. Equilibrium with CP was, however, predicted on occasion in both Tank 2 and 3.

Co-precipitation with HA is also a possible attenuation mechanism for Cd and Fe (and possibly Mn). The positive correlations between solid phase metal concentrations for Fe, Pb, Cd and Mn suggests a similar attenuation mechanism and/or attenuation under similar geochemical conditions. Inclusion of these constituents in a secondary phosphate mineral phase is one such mechanism.

Surface Reactions. Adsorption of Pb, Cd and Mn onto ferrihydrite or the Apatite IITM treatment medium (Wright et al., 2004) would also account for the positive correlation observed between the solid phase concentrations of these metals. Iron oxide staining is observed at the adit and the treatment tank outflows. Wright (2004) cites studies that showed Apatite IITM will adsorb up to 5% of its weight in metals. The mineralogical analysis conducted to date is not capable of characterizing surface reactions such as adsorption. More sophisticated analytical techniques and analysis would be required to make a definitive conclusion regarding the role of this process at the Nevada Stewart Site.

Acknowledgements

This project was conducted under the U.S. Environmental Protection Agency's (EPA) Mine Waste Technology Program (MWTP). The MWTP is operated by MSE with administrative assistance from the U.S. DOE's Western Environmental Technology Office under DOE Contract Number DE-AC09-96EW96405 and technical direction from EPA's National Risk Management Research Laboratory under Interagency Agreement Number DW-89939550-01-1.

Literature Cited

- Anderson, S. and D. Clary, 2004. Removal of Dissolved Metals from Nevada-Stewart Mine Water Using Fish Bone Apatite, prepared for MSE-TA, Inc., July 2004.
- Benner, S.G., Blowes, D.W., and C.J. Ptacek, 1997. A Full-Scale Porous Reactive Wall for Prevention of Acid Mine Drainage. *Groundwater Monitoring and Remediation*, 17(4), Fall 1997, pp. 99-107. <http://dx.doi.org/10.1111/j.1745-6592.1997.tb01269.x>
- Bostick, W.D., Stevenson, R.J., Jarabek, R.J., and J.L. Conca, 2000. Use of apatite and bone char for the removal of soluble radionuclides in authentic and simulated DOE groundwater. *Advances in Environmental Research*, 3(4), pp. 488-498.
- Carodona, M.E., 2000. Phosphorus Contributions from OSWS, <http://plymouth.ces.state.nc.us/septic/98cardonaphos.html>.
- Chen, X., Wright, J.V., Conca, J.L., and L.M. Peurrung, 1997a. Effects of pH on Heavy Metal Sorption on Mineral Apatite. *Environmental Science and Technology*, 31(3), pp. 624-631. <http://dx.doi.org/10.1021/es950882f>.

- Chen, X., Wright, J.V., Conca, J.L. and L.M. Peurrung, 1997b. Evaluation of Heavy Metal Remediation Using Mineral Apatite. *Water, Air and Soil Pollution*, 98, pp. 57 to 78.
- Clary, 2004. Determining the Removal Mechanisms of Fishbone Apatite for Cadmium, Lead and Zinc From the Nevada-Stewart Adit Discharge Water, M.Sc. thesis, Montana Tech of the University of Montana, Butte, Montana.
- Golder Associates Inc., 2003. Final Report on September 2002 to June 2003 Effectiveness Monitoring Groundwater Treatment Facility Success Mine and Mill Site, Wallace, Idaho. Submitted to Terragraphics Environmental Engineering Inc.
- Ma, Q.Y., Traina, T.J., and T.J. Logan, 1993. In Situ Lead Immobilization by Apatite. *Environmental Science and Technology*, 27(9), pp. 1803-1810. <http://dx.doi.org/10.1021/es00046a007>.
- Ma, Y.Q., Logan, T.J., and S.J. Traina, 1994. Effects of NO₃⁻, Cl⁻, F⁻, SO₄²⁻ and CO₃²⁻ on Pb²⁺ Immobilization by Hydroxyapatite. *Environmental Science and Technology*, 28(3), pp. 408-418. <http://dx.doi.org/10.1021/es00052a011>
- Parkhurst, D.L., and C.A.J. Appelo, 1999. User's Guide to PHREEQC (Version 2) - A Computer Program for Speciation, Batch-Reaction, One-Dimensional Transport, and Inverse Geochemical Calculations, U.S. Geological Survey Water-Resources Investigations Report 99-4259, Denver, CO.
- Turek, S.L., and J.B. Lippincott, 1985. *Orthopedics: Principles and Applications*, 2nd Edition, pp. 113 and 136.
- Wright, J., Conca, J. L., Rice, K. R., and B. Murphy, 2004. PIMS Using Apatite IITM: How It Works To Remediate Soil and Water, in *Sustainable Range Management*, Eds., R.E. Hinchee and B. Alleman, Battelle Press, Columbus, OH.
- Xu, Y and F.W. Schwartz, 1994. Lead immobilization by hydroxyapatite in aqueous solutions. *Journal of Contaminant Hydrology*, 15, pp. 187-206. [http://dx.doi.org/10.1016/0169-7722\(94\)90024-8](http://dx.doi.org/10.1016/0169-7722(94)90024-8).
- Zanini, L., Robertson, W.D., Ptacek, C.J., Schiff, S.L., and T. Mayer, 1998. Phosphorus Characterization in Sediments Impacted by Septic Effluent at Four Sites in Central Canada, *Journal of Contaminant Hydrogeology*, 33, pp. 405-429. [http://dx.doi.org/10.1016/S0169-7722\(98\)00082-5](http://dx.doi.org/10.1016/S0169-7722(98)00082-5).